

REGATTA CREW
SURF EDITION



esta
home.nl

The background of the entire page consists of vertical stripes in various shades of blue, grey, and red. The stripes vary in width and color, creating a rhythmic, textured effect.

esta
home.nl

1-6901



1-6901

esta
home.nl

esta
home.nl



esta
home.nl

1-6819



31

72

1-6819



esta
home.nl



138947

esta
home.nl



137722

esta
home.nl

138815



beschuit
Hille

138815



esta
home.nl

138816



138816

esta
home.nl

138814



esta
home.nl

138814



vsta
home.nl

128871



Figure-8 Knot



Flemish Loop



Reef Knot



Sheet Bend



Overhand Knot



Spedlock Knot



Slip Knot



Running Bowline



Weaver's Knot



Boat Knot



Carrick Bend



Two Half Hitches



Reef Knot



Sheet Bend



Figure-8 Knot



Flemish Loop



Slip Knot



Running Bowline



Overhand Knot



Spedlock Knot



Carrick Bend



Two Half Hitches



Weaver's Knot



Boat Knot

esta
home.nl



1-6941

fish

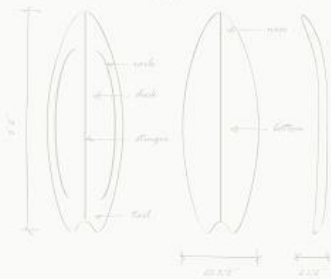

shortboard

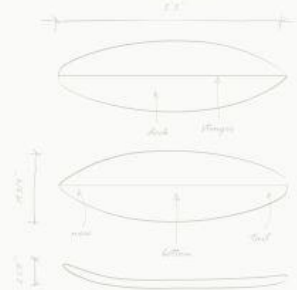

longboard

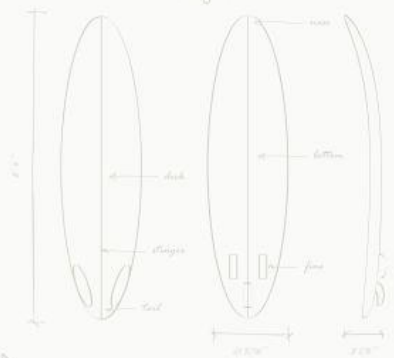

hybrid

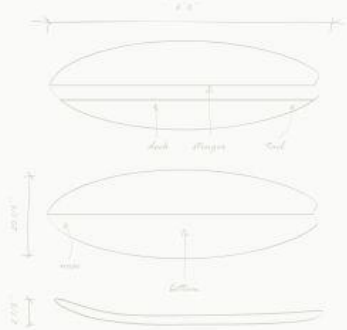

gunboard

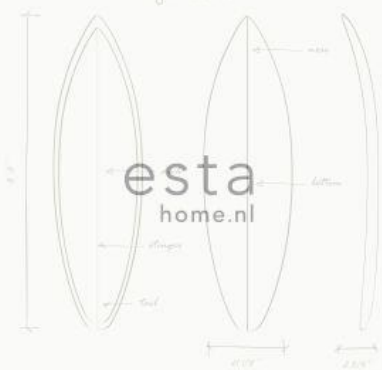

egg

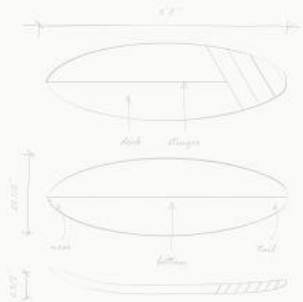

esta
home.nl

malibu

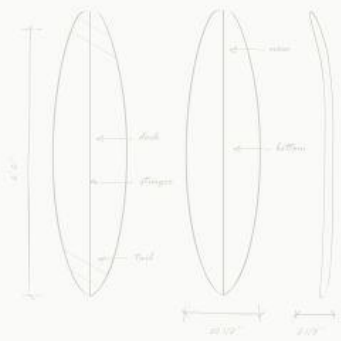

funboard

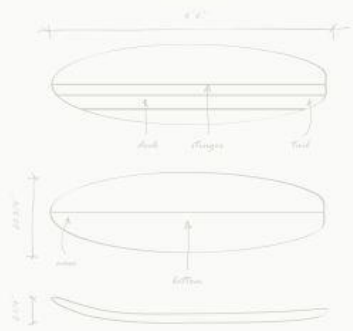

soft-top

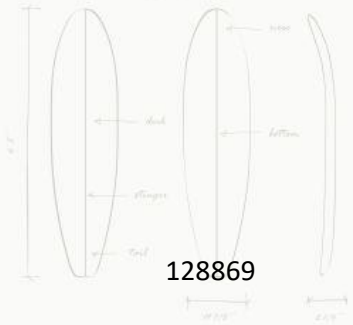

128869

fish

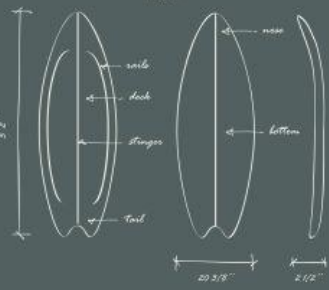

shortboard

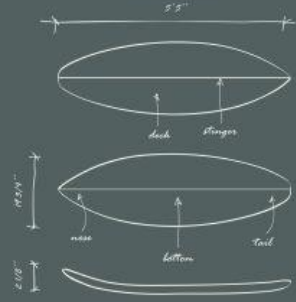

longboard

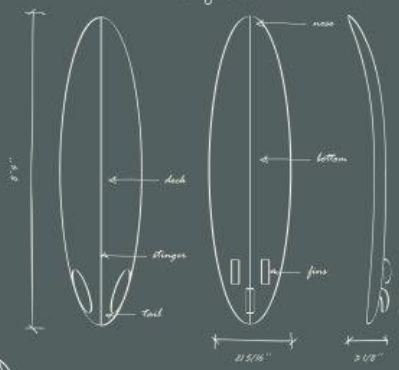

hybrid

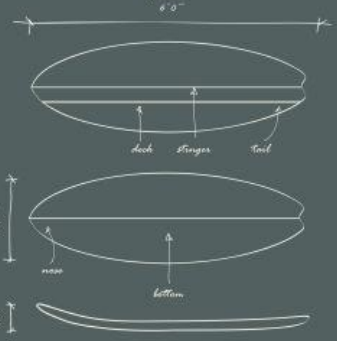

gunboard

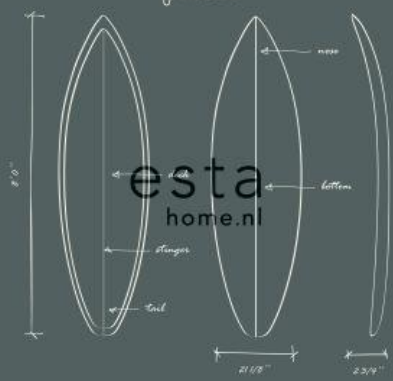

egg

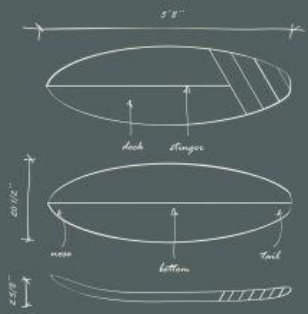

malibu

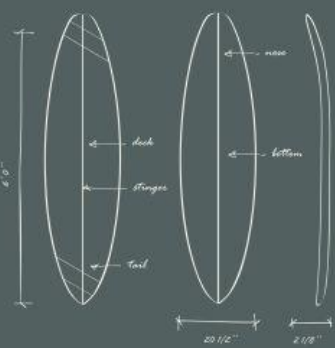

funboard

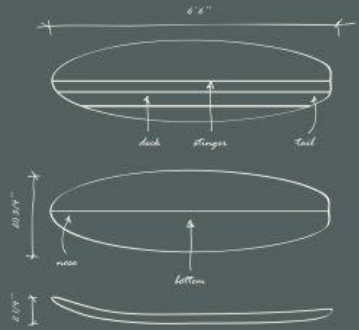

soft-top

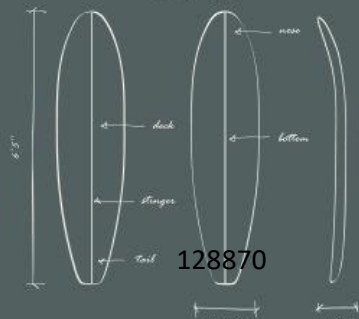

esta home.nl

128870

fish

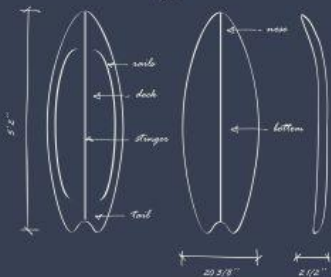

shortboard

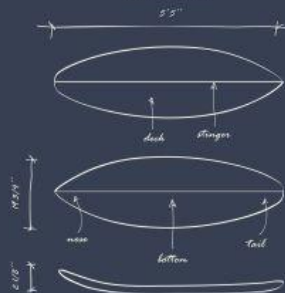

longboard

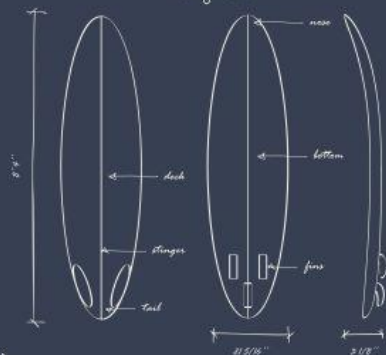

hybrid

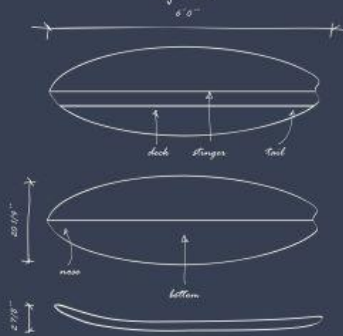

gunboard

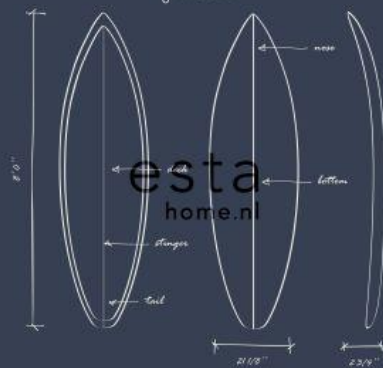

egg

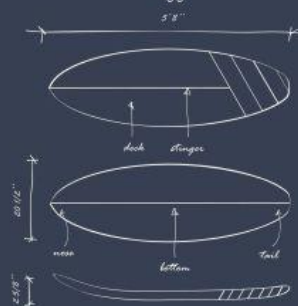

malibu

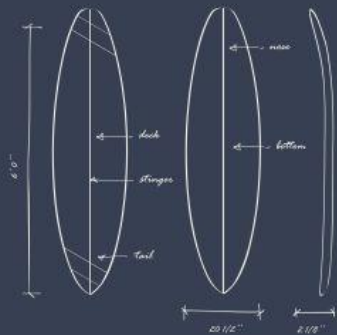

funboard

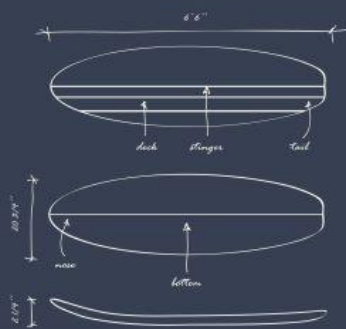

soft-top

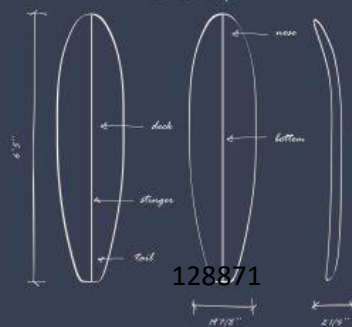

128871

fish

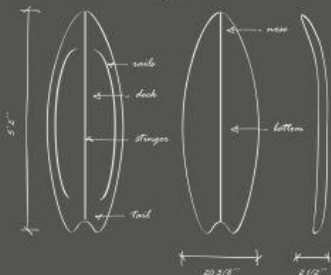

shortboard

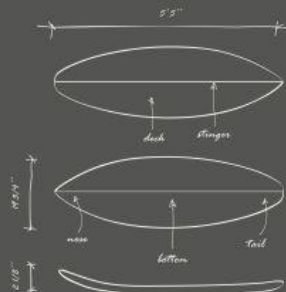

longboard

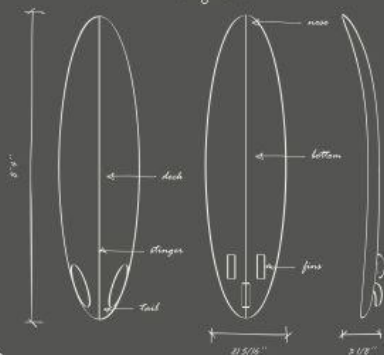

hybrid

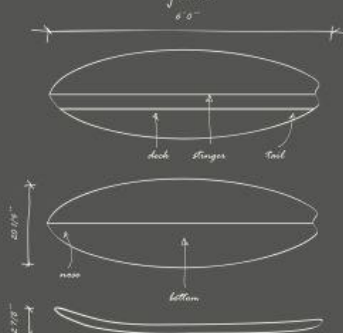

gunboard

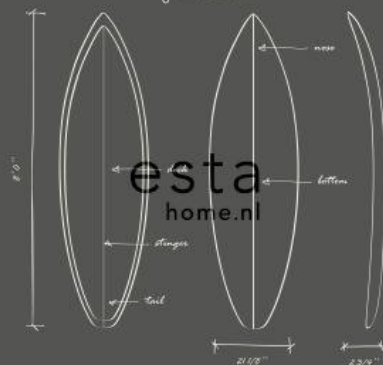

egg

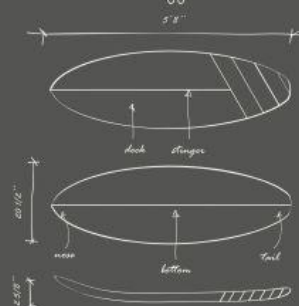

malibu

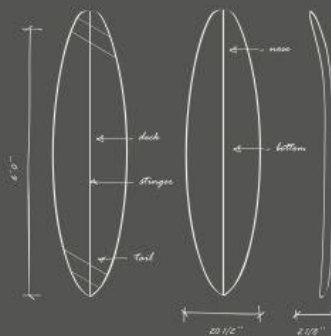

funboard

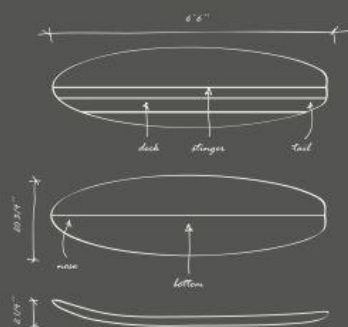

soft-top

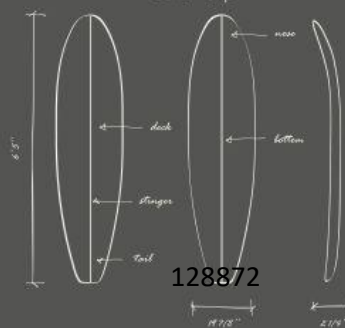

esta
home.nl

128872



esta
home.nl

128874



esta
home.nl

136465

esta
home.nl



esta
home.nl

138819



esta
home.nl

138821



138821



esta
home.nl

138822



138822



138948



138948



esta
home.nl



3

Do What You
Love
and
Love
What You Do

72

31

138949



esta
home.nl

esta
home.nl

138951



138951



esta
home.nl

138952



38952



esta
home.nl

138953







138954



esta
home.nl

138957

DVENTURE DIVE SUNSET SAILING FLYING ANCHOR A
SHELLS BOAT OCEAN TRAVELING NAVY BEACH SEA
S SURFING NORTHSEA WINDWARD COMPASS WAVE
ACHTING FRIENDS CRUISE AHOY MARINE FISHING Y
E WATERCRAFT ABOARD BAY LIFETIME SPORT ROP
OAR LIFEGUARDS PADDLING SNORKEL ATLANTIC R
JOY SHORE SHORTBOARD FERRY SUMMER FUN EN
SAILOR ROWING SWIMSUITS HOLIDAYS ROWBOAT
UDES BOARD LIFEBOAT SHIP RIVER CORAL SURFD
DVENTURE DIVE SUNSET SAILING FLYING ANCHOR A
SHELLS BOAT OCEAN TRAVELING NAVY BEACH SEA
S SURFING NORTHSEA WINDWARD COMPASS WAVE
ACHTING FRIENDS CRUISE AHOY MARINE FISHING Y
E WATERCRAFT ABOARD BAY LIFETIME SPORT ROP
OAR LIFEGUARDS PADDLING SNORKEL ATLANTIC R
JOY SHORE SHORTBOARD FERRY SUMMER FUN EN
SAILOR ROWING SWIMSUITS HOLIDAYS ROWBOAT
UDES BOARD LIFEBOAT SHIP RIVER CORAL SURFD

esta
home.nl

DVENTURE DIVE SUNSET SAILING FLYING ANCHOR A
SHELLS BOAT OCEAN TRAVELING NAVY BEACH SEA
S SURFING NORTHSEA WINDWARD COMPASS WAVE
ACHTING FRIENDS CRUISE AHOY MARINE FISHING Y
E WATERCRAFT ABOARD BAY LIFETIME SPORT ROP
OAR LIFEGUARDS PADDLING SNORKEL ATLANTIC R
JOY SHORE SHORTBOARD FERRY SUMMER FUN EN
SAILOR ROWING SWIMSUITS HOLIDAYS ROWBOAT
UDES BOARD LIFEBOAT SHIP RIVER CORAL SURFD
DVENTURE DIVE SUNSET SAILING FLYING ANCHOR A
SHELLS BOAT OCEAN TRAVELING NAVY BEACH SEA
S SURFING NORTHSEA WINDWARD COMPASS WAVE
ACHTING FRIENDS CRUISE AHOY MARINE FISHING Y
E WATERCRAFT ABOARD BAY LIFETIME SPORT ROP
OAR LIFEGUARDS PADDLING SNORKEL ATLANTIC R
JOY SHORE SHORTBOARD FERRY SUMMER FUN EN
SAILOR ROWING SWIMSUITS HOLIDAYS ROWBOAT
UDES BOARD LIFEBOAT SHIP RIVER CORAL SURFD

esta
home.it

VENTURE DIVE SUNSET SAILING FLYING ANCHOR A
HELLS BOAT OCEAN TRAVELING NAVY BEACH SEA
SURFING NORTHSEA WINDWARD COMPASS WAVE
CHTING FRIENDS CRUISE AHOY MARINE FISHING Y
WATERCRAFT ABOARD BAY LIFETIME SPORT ROP
AR LIFEGUARDS PADDLING SNORKEL ATLANTIC R
DY SHORE SHORTBOARD FERRY SUMMER FUN EN
SAILOR ROWING SWIMSUITS HOLIDAYS ROWBOAT
DES BOARD LIFEBOAT SHIP RIVER CORAL SURFD
VENTURE DIVE SUNSET SAILING FLYING ANCHOR A
HELLS BOAT OCEAN TRAVELING NAVY BEACH SEA
SURFING NORTHSEA WINDWARD COMPASS WAVE
CHTING FRIENDS CRUISE AHOY MARINE FISHING Y
WATERCRAFT ABOARD BAY LIFETIME SPORT ROP
AR LIFEGUARDS PADDLING SNORKEL ATLANTIC R
DY SHORE SHORTBOARD FERRY SUMMER FUN EN
SAILOR ROWING SWIMSUITS HOLIDAYS ROWBOAT
DES BOARD LIFEBOAT SHIP RIVER CORAL SURFD

esta
home.it

138960

DVENTURE DIVE SUNSET SAILING FLYING ANCHOR A
SHELLS BOAT OCEAN TRAVELING NAVY BEACH SEA
S SURFING NORTHSEA WINDWARD COMPASS WAVE
ACHTING FRIENDS CRUISE AHOY MARINE FISHING Y
E WATERCRAFT ABOARD BAY LIFETIME SPORT ROP
OAR LIFEGUARDS PADDLING SNORKEL ATLANTIC R
JOY SHORE SHORTBOARD FERRY SUMMER FUN EN
SAILOR ROWING SWIMSUITS HOLIDAYS ROWBOAT
UDES BOARD LIFEBOAT SHIP RIVER CORAL SURFD
DVENTURE DIVE SUNSET SAILING FLYING ANCHOR A
SHELLS BOAT OCEAN TRAVELING NAVY BEACH SEA
S SURFING NORTHSEA WINDWARD COMPASS WAVE
ACHTING FRIENDS CRUISE AHOY MARINE FISHING Y
E WATERCRAFT ABOARD BAY LIFETIME SPORT ROP
OAR LIFEGUARDS PADDLING SNORKEL ATLANTIC R
JOY SHORE SHORTBOARD FERRY SUMMER FUN EN
SAILOR ROWING SWIMSUITS HOLIDAYS ROWBOAT
UDES BOARD LIFEBOAT SHIP RIVER CORAL SURFD

esta
homa

DVENTURE DIVE SUNSET SAILING FLYING ANCHOR A
SHELLS BOAT OCEAN TRAVELING NAVY BEACH SEA
S SURFING NORTHSEA WINDWARD COMPASS WAVE
ACHTING FRIENDS CRUISE AHOY MARINE FISHING Y
E WATERCRAFT ABOARD BAY LIFETIME SPORT ROP
OAR LIFEGUARDS PADDLING SNORKEL ATLANTIC R
JOY SHORE SHORTBOARD FERRY SUMMER FUN EN
SAILOR ROWING SWIMSUITS HOLIDAYS ROWBOAT
UDES BOARD LIFEBOAT SHIP RIVER CORAL SURFD
DVENTURE DIVE SUNSET SAILING FLYING ANCHOR A
SHELLS BOAT OCEAN TRAVELING NAVY BEACH SEA
S SURFING NORTHSEA WINDWARD COMPASS WAVE
ACHTING FRIENDS CRUISE AHOY MARINE FISHING Y
E WATERCRAFT ABOARD BAY LIFETIME SPORT ROP
OAR LIFEGUARDS PADDLING SNORKEL ATLANTIC R
JOY SHORE SHORTBOARD FERRY SUMMER FUN EN
SAILOR ROWING SWIMSUITS HOLIDAYS ROWBOAT
UDES BOARD LIFEBOAT SHIP RIVER CORAL SURFD

esta
home



esta
home.nl

138964



esta
home.nl



esta
home.nl

138966

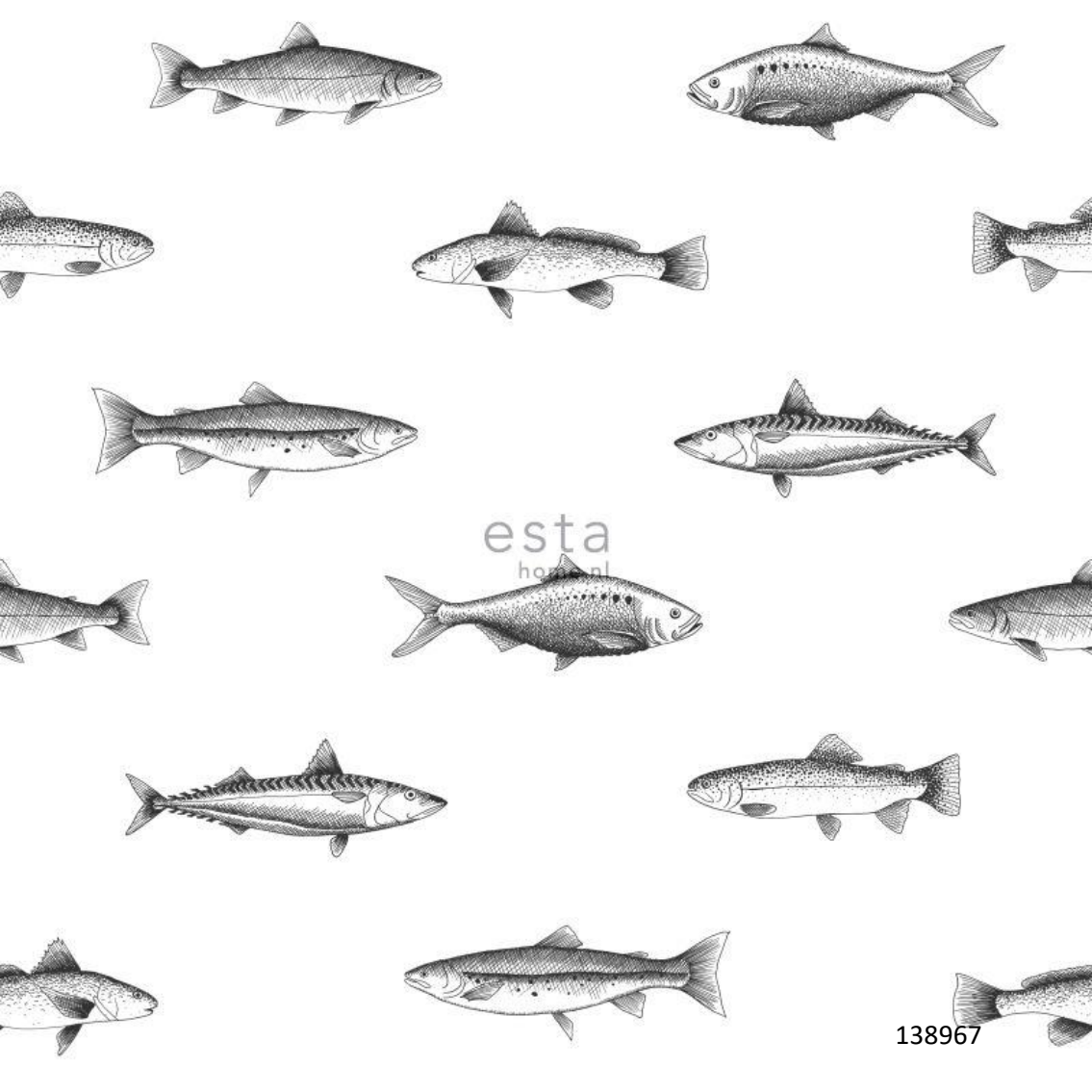

esta
ho...nl

esta
home.nl

138968

esta
home.nl

esta
home.nl



esta

ATLANTIC OCEAN

PACIFIC OCEAN

INDIAN OCEAN

PACIFIC OCEAN

AMERICA

ASIA

AUSTRALIA

EUROPA

AFRICA





ATLANTIC OCEAN

PACIFIC OCEAN

Estados Unidos

PACIFIC OCEAN

INDIAN OCEAN

AMERICA

ASIA

AUSTRALIA

EUROPA

AFRICA



138972



esta



138973



138974







esta
home.nl

138977



esta
home.nl

138978





138980

esta
home.nl

esta
home.nl

esta
home.nl

148603

esta
home.nl

148604

esta
home.nl

esta
home.nl

esta
home.nl

esta
home.nl

148704

esta
home.nl

esta
home.nl

esta
home.nl

esta
home.nl



158846

esta
home.nl



158847

esta
home.nl



158850



WALLPAPERS

Para dúvidas ou consultas entre em contato pelo WhatsApp
(11) 99333-5590 ou pelo atendimento@musewallpapers.com.br.

Siga-nos também nas redes sociais



/musewallpapers